

6 Adaptive modell-prädiktive Regelung der Prozesse in Zellstoff- und Papierfabriken

Model-based predictive adaptive control of pulp and paper mill processes

B. GOUGH, Richmond, Kanada
D. MEADE, Richmond, Kanada
G. ENGLAND, Richmond, Kanada
S. KOVAC, Richmond, Kanada

Abstract

This paper describes the application of a model based predictive adaptive process controller on a number of challenging pulp and paper mill control loops including paper machine reel brightness control, lime kiln temperature profile control, slaker temperature control, and Extraction Stage pH control. These loops are difficult to control due to the time delay present in the response. Consequently, many of these processes are manually controlled resulting in inefficient operation and increased operator work load. Paper making includes many such processes that cannot be well controlled with conventional PID techniques. Model predictive control provides a practical alternative to achieve significant reduction in process variability to reduce operating costs.

Bill Gough
Duncan Meade
Graham England
Sava Kovac
IDEAS Simulation & Control Ltd.
100-13700 International Place
Richmond, BC V6V 2X8
Canada
bill.gough@andritz.com

Keywords

Model-Based Predictive Adaptive Control, BrainWave, Reel Brightness, Slaker Temperature, Lime Kiln Control, Extraction pH control, Pulp and Paper Process Control

1 Introduction

Paper making presents many challenging control problems due to the long response times present in several key areas of the paper making process. Processes with long response time and long time delays are difficult to control with conventional PID technology and are often manually controlled by the operator resulting in high process variability and increased operating costs. Examples of such processes include the control of digester level, temperature, and kappa number, pulp brightness and pH control in the bleach plant, lime kiln temperature and recaust controls, TMP refiner load control, and many paper machine processes. Due to the high variability inherent in the mill feed stock, the controls must deal with frequent disturbances in order to maintain the process at the specified targets. The difficult control dynamics of these key paper making processes, combined with the need for optimal disturbance rejection to achieve low production cost, presents an opportunity for the application of advanced control techniques.

Advanced control is a broad term that includes everything from complex PID based control strategies to supervisory optimization systems. However, to address the fundamental control requirements of the key paper making processes, what is needed is a regulatory level controller that can handle the long response times and process disturbances better than conventional PID control. Model predictive control (MPC) is a well proven method for dealing with long process time delays. It also provides an elegant framework for including measured disturbances as feed forwards in the control design, and can also solve multivariable systems such as interacting control loops using the same design methodology. In short, model predictive control provides a good solution for most of the common control problems where PID control does not perform well, making it the ideal alternative for papermakers to optimize the control of their plants.

MPC allows paper makers to approach their control problems using a consistent method that is based on understanding the process response. MPC forces the control technician to examine the process response and eliminates the ability to just dial down the PID tuning parameters until stable control is achieved. This step ensures that the actual changes that are occurring in the process response itself are recognized so that the control solution can be modified to address and solve the problem. By doing so, MPC helps the control system evolve to a more complete and optimal solution, compared to the typical PID approach which leads to the controller being de-tuned to a lowest common denominator solution that is stable under all plant conditions but is optimal for none.

Historically, model predictive control has been difficult and expensive to implement due to the implementation effort and the level of expertise required to apply the technology. This is due to several factors, including the complexity of the model to be developed as well as the academic nature of many of the software tools developed to implement model predictive control techniques.

This paper describes the application of a model-based predictive adaptive (MPC) controller, commercially known as BrainWave®, to various paper making processes. This controller is a patented (US Patent #5,335,164) PC-based commercial software package with over 1,000 installations around the world in many different process industries. The predictive control capability enables significant performance improvements compared to manual or other automatic control strategies. Variability reductions of 50% or more are typically achieved using this technique.

As discussed, obtaining a process response model is a key part of the implementation of an MPC controller. In our design, the controller models the system response using a generic function series approximation technique based on Laguerre polynomials. This approach provides a simple and efficient method to mathematically model the process response with a minimum of a priori information. It also enables the controller to perform online adaptation of the process response models automatically. These factors reduce the implementation effort and contribute to quick installation times for the MPC controller, typically about 1 week per application. The adaptive capabilities assist the control technician with developing the process response models, so the same good result will be achieved regard-

less of the expertise level of the person doing the application. For industrial customers that operate large plants with thousands of process controllers, this benefit alone is extremely valuable.

Using these models as the basis for a predictive control design, the MPC is able to control processes with long delay or response times (or fast response processes where the time delay is a significant part of the response dynamics) better than is possible using PID type controllers. This technique can also be used to automatically model and counteract the effects of measured disturbances by incorporating them into the control strategy as feedforward variables. The following sections describe the Laguerre modeling method used in the design of the MPC controller and the results of applications on paper machine reel brightness control, lime kiln control, slaker/recaust control, and extraction stage pH control.

2 Model-Based Predictive Adaptive Controller Development

The first step in designing a model-based predictive adaptive controller is to build a mathematical representation of the process response, or model, for the system to be controlled. Our controller uses a method of process transfer function modeling developed at the University of British Columbia by Dr. Guy Dumont and Dr. Chris Zervos [1-6]. This method reduces the effort required to obtain accurate process model as it is able to automatically build a transfer function model using a series of orthonormal Laguerre functions by observing process response data collected while controlling the process online. A complete development of the control algorithm is given in [7, 8].

The Laguerre function series is defined as:

$$l_i(t) = \sqrt{2p} \frac{e^{pt}}{(i-1)!} \frac{d^{i-1}}{dt^{i-1}} [t^{i-1} e^{-2pt}] \quad (1)$$

where: $i = 1$ to N
 p = Laguerre Pole
 t = time

Summing each with an appropriate weighting factor approximates a process transfer function:

$$g(t) = \sum_{i=0}^{i=\infty} c_i l_i(t) \quad (2)$$

where: $g(t)$ = Process transfer function
 c = i th Laguerre coefficient

An analogy to this method is the use of Cosine functions in the Fourier series method to approximate periodic signals as is common in frequency analyzers. In this case, weights for each Cosine function in the series are determined such that when the weighted Cosine functions are summed, a reasonable approximation of the original signal is obtained. In this case, the signal is represented by its frequency spectrum.

In process control, the process transfer functions are transient in nature and are not periodic, so Cosine functions are not an appropriate choice as a basis for the model. However, the elegance of the Fourier series technique provides many advantages such as simple and efficient model structure and excellent parameter convergence when estimating the model from observed data sets. The motivation of our research was to find an equally simple and efficient method to model the transient responses common in process control applications

The Laguerre functions are well suited to modeling the types of transient signals found in process control because they have similar behavior to the processes being modeled. In addition, the Laguerre functions are able to efficiently model the dead time in the process response. This model is used as a basis for the design of the predictive adaptive regulatory controller using a simple d -steps ahead pre-

dictive control law to forecast process response so that set point is attained as rapidly as possible with little or no overshoot.

The MPC controller is interfaced to existing mill DCS or PLC systems by using OLE for Process Control (OPC). Logic is required to be programmed into the mill DCS or PLC system to determine the mode for the control loops (i.e., manual, PID Auto, or Computer Auto). The controller maintains a bi-directional heartbeat with the logic program such that the control mode will automatically fall back to the original control in the event of a computer or network fault. When available, measured disturbances from upstream processes can be used by the controller as feed forward inputs to improve the overall performance. Additionally, the controller can automatically switch between a number of pre-configured models and parameter settings to deal with sudden changes in process dynamics that are typically caused by production rate or grade changes.

3 Reel Brightness Control

Typical reel brightness control is open loop, with an operator taking paper samples at discrete time intervals and using standard laboratory techniques to measure the brightness and opacity of the paper. The time between samples generally approaches one hour, with the operator only making chemical addition changes following the results of each laboratory test. This often results in poor paper brightness control, together with poor chemical consumption due to the tendency of the operator to control to a conservative (higher) brightness target to avoid the production of off-spec paper. A continuous reel brightness control scheme would result in improved paper quality with improved chemical consumption, together with savings in operator workload. A schematic of the control scheme is shown in Figure 1.

The DCS system used at the mill is an MXOpen system. The OPC connection between the MPC control system and the MXOpen DCS was achieved using LegacyConnect for Measurex ODX by Infor-metric. Sodium hydrosulfite was used as the brightening chemical for the pulp. Process response tests indicated a dead time of approximately 20 minutes, with a change in sodium hydrosulfite of 5 gallons/minute resulting in the Measurex scanner reporting a 1.5 ISO change in brightness, with a time constant of approximately one hour. Using these process dynamics, a controller update of five minutes was configured, with an upper output limit of 12 gallons/minute (the same high limit used by the operator under manual control). The upper limit has been empirically shown to be the saturation value for the sodium hydrosulfite, with very minimal increases in brightness observed at higher doses beyond this level. A 120-second filter was applied to the scanner brightness measurement to reduce high frequency noise in process data. This filter is sufficiently small relative to the dynamics such that it will not interfere with control.

Additional process data comes from the stock storage brightness and the residual peroxide. The stock storage brightness is measured prior to the addition of any broke stock. Since the addition of broke stock changes the pulp brightness, using the stock storage brightness as a feedforward signal in the control strategy would not be ideal. The residual peroxide measurement, measured at the stock storage, could not be used owing to lack of instrument calibration. However, this could be used in future to optimize the chemical addition to the pulp since both peroxide and sodium hydrosulfite are used to maintain paper brightness.

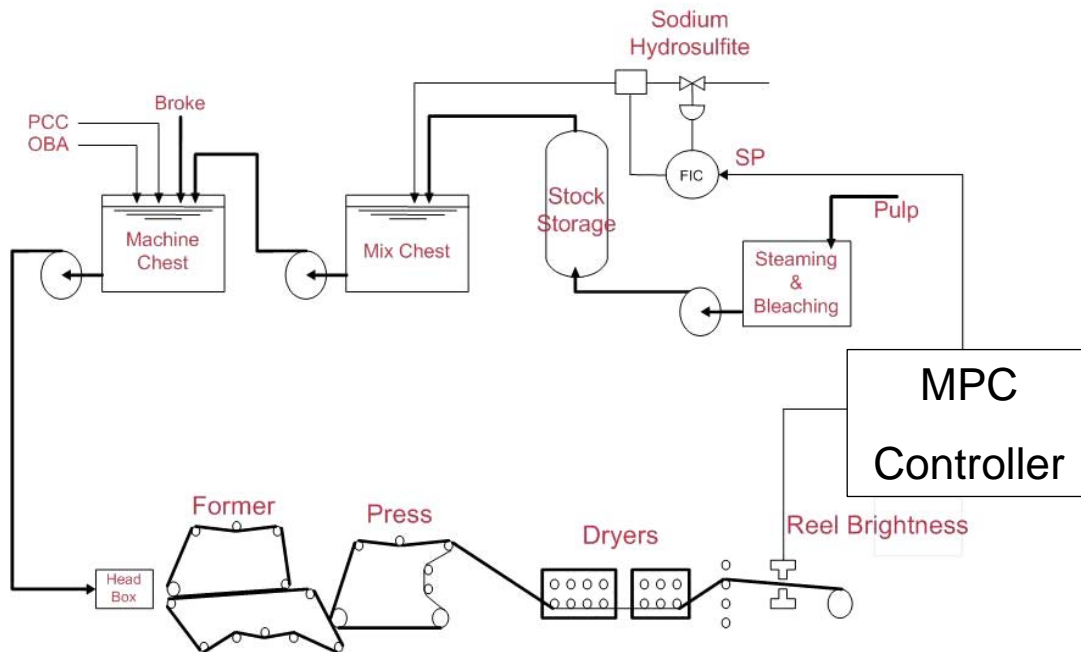

Figure 1: Reel Brightness Control Scheme

Figure 2 shows a four day period of MPC control of reel brightness. It can be seen that a number of set point changes are made by the operator, ranging from 75 ISO down to 60 ISO. Initially the lower limit for the sodium hydrosulfite flow was set to 2 gallons/minute; this was lowered to 1 gallon/minute, then finally 0.5 gallon/minute since the sodium hydrosulfite flow is being continually manipulated by the controller.

Results from the first 2 months of production are shown in Table I. These results indicate a significant reduction of sodium hydrosulfite consumption per ton of paper production. Operation during February was a mix of manual control and MPC control as the MPC was commissioned during this period so chemical savings during this period are only due to the fraction of the time that the MPC was in control of the process. The higher brightness grades show a reduction in chemical consumption of between 15 and 75% comparing January production (prior to the MPC installation) with March production (when fully controlled by the MPC). For example, comparing the production of the very high brightness 83 grades, a reduction of 44% was observed. For this mill, the annual chemical consumption was typically in excess of \$500,000 USD. A reduction of 40% provides annual savings of about \$200,000 USD, resulting in a project payback period of less than 6 months.

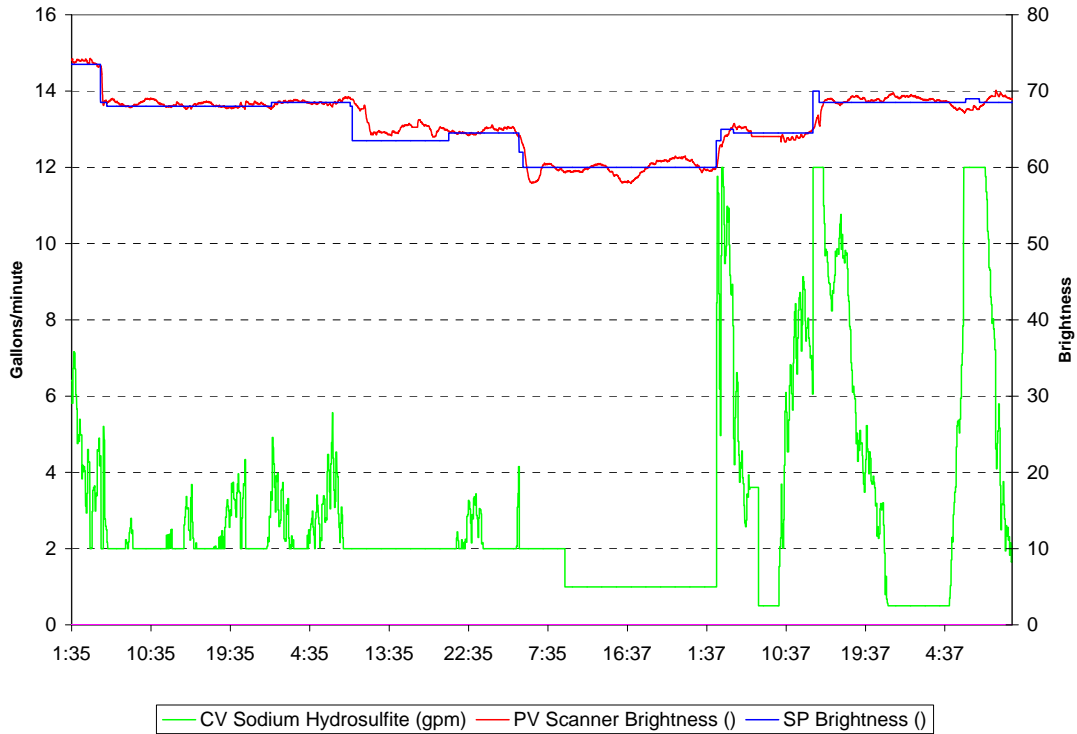

Figure 2: Scanner Brightness Performance in MPC Control

Table I: Sodium Hydrosulfite Consumption

Target Brightness	Sodium hydrosulfite lb/Paper Tons			% Reduction Jan-Mar	% Reduction Feb-Mar
	January (Manual Control)	February (Commissioning)	March (MPC Control)		
75	9.49	7.53	2.28	75.96	69.7
80	8.79	11.35	7.41	15.71	34.7
83	-	18.93	10.59	-	44.1

4 Lime Kiln Control

Lime kiln temperature profile is typically manually controlled due to the long time delays and multivariable interactions of the draft and fuel on the kiln temperature profile that make automatic control with PID impractical. Response times of one hour or more are typical. Operators are often impatient with the long response time of this system and tend to make large corrections to the fuel feed rate in an attempt to recover the temperature profile quickly during process disturbances such as production rate changes. These actions result in extremes of temperature in the kiln, leading to ring formation problems as well as reduced refractory life. Operators also tend to control the temperature profile at a higher value than necessary for the lime burning and at a high excess oxygen level to provide a comfortable operating margin that requires less frequent attention. These practices lead to increased fuel consumption and maintenance costs.

Adjusting draft and fuel cause shifts in the flame length and excess oxygen levels. In addition to the long response times, this interaction must also be addressed by the control strategy to achieve responsive yet stable control performance. The ultimate objective of the control strategy is to maintain a constant lime discharge temperature to ensure consistent lime quality as measured by LOI and reactivity (slaking rate). A supervisory MPC controller is used to control the lime discharge temperature by

adjusting the target for the feed end temperature controller. This approach allows feed end temperature limits to be easily included in the control strategy. A schematic of the control scheme is given in Figure 3.

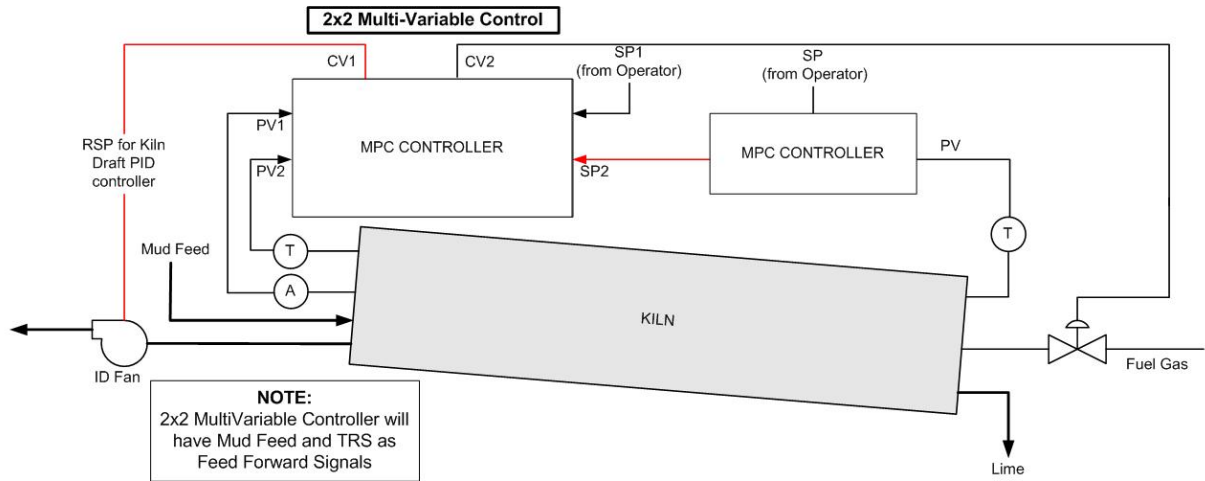

Figure 3: Lime Kiln MPC Control Scheme

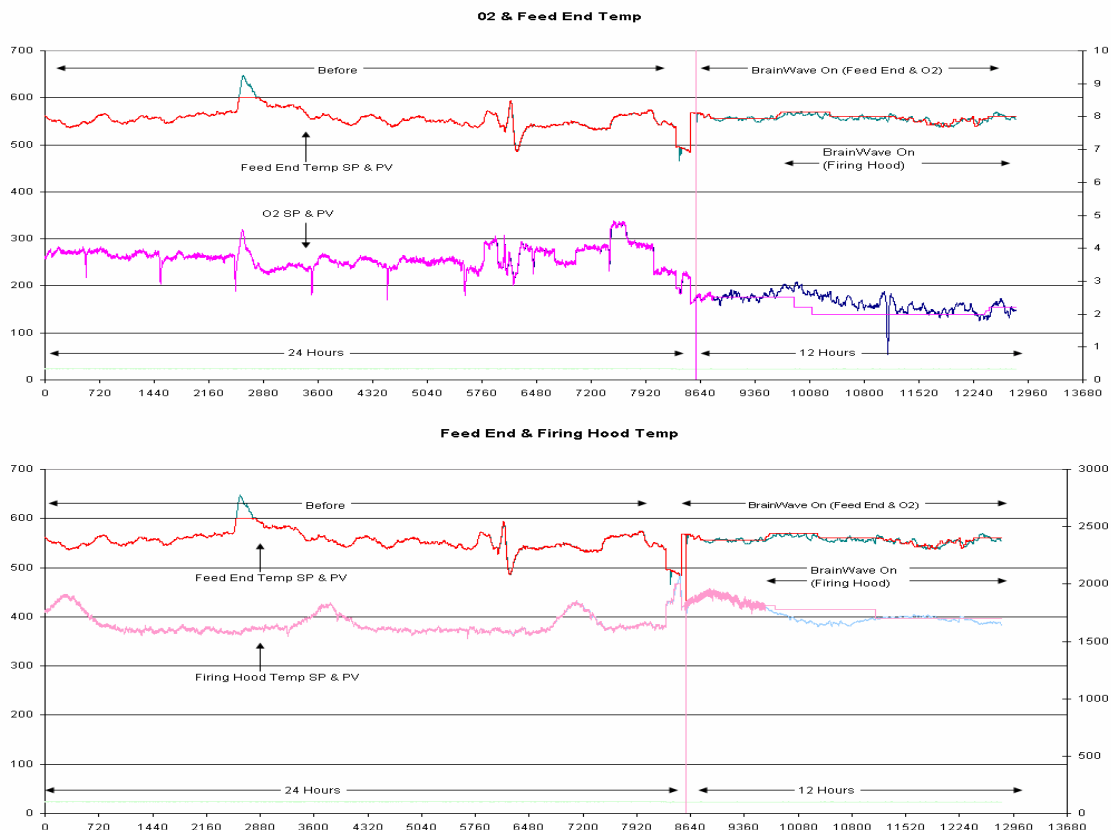

Figure 4: Lime Kiln Control Comparison

A summary of the performance improvements obtained by the MPC controller on this application is shown in Table II. The range of variation of each process variable was substantially reduced, allowing the kiln to operate at a lower average temperature with lower excess oxygen. These improvements resulted in reduced fuel consumption and reduced incidence of ring formation. Based on the results of this application, as well as experience with several other MPC applications on lime mud kilns, the return on investment for the MPC control system is three to six months.

Table II: Lime Kiln Performance Comparison

PROCESS VARIABILITY	MANUAL CONTROL	MPC CONTROL	IMPROVEMENT
Excess Oxygen	1%	0.3%	70%
Feed Temperature	40°F	7°F	82%
Lime Temperature	200°F	25°F	87%

5 Slaker Temperature Control

Within the recaust area of a pulp mill, slaker temperature and recausticizer conductivity are typically controlled manually. Again, achieving automatic control is difficult due to the slow dynamics that the process exhibits. Using the MPC controller, these slow dynamics are easily modeled and allow tight control. A schematic of the control scheme is shown in Figure 5.

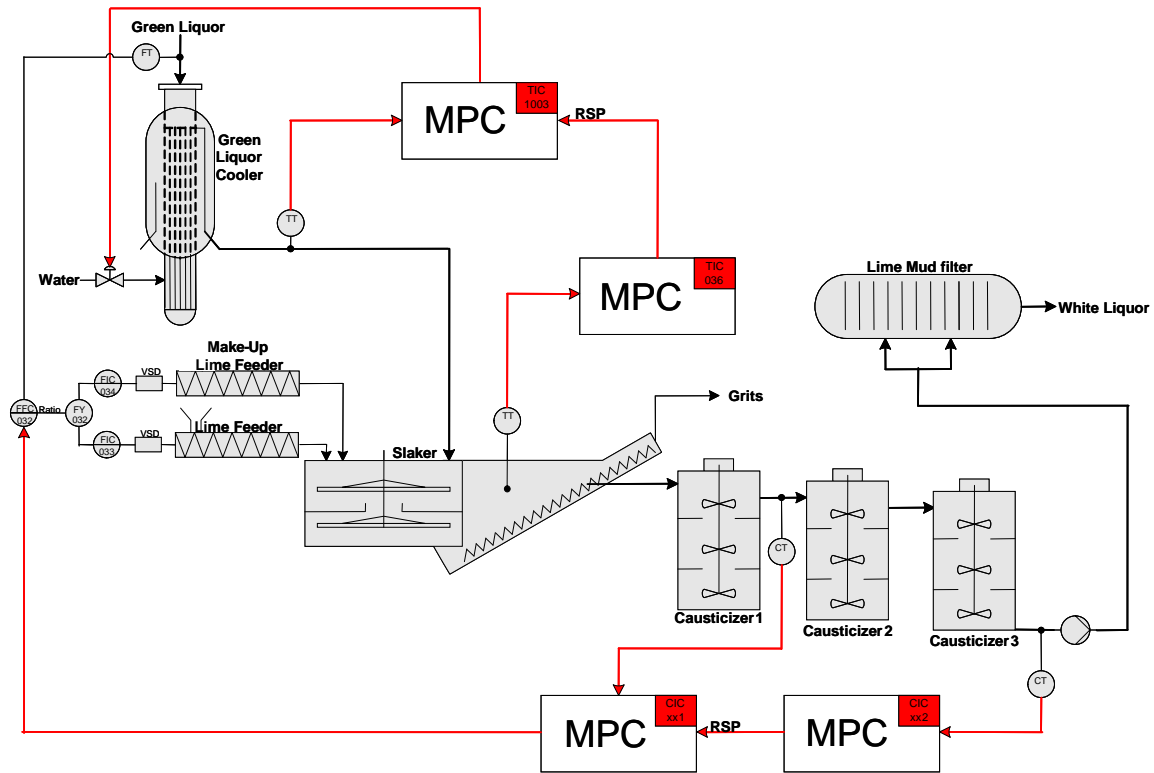

Figure 5: Slaker Temperature and Recaust Control Scheme

The operator will set the slaker temperature set point; the MPC slaker temperature controller will adjust the set point to an inner loop controller that will maintain the green liquor temperature entering the slaker. This green liquor temperature controller can be either MPC or PID since the dynamics of the green liquor temperature loop at this mill are reasonably fast with little dead time. The MPC slaker temperature controller has a feedforward signal of the lime feed since any change to this feed rate will affect the slaker temperature. The lime feed is automatically adjusted by the recausticizer conductivity control scheme, so it will be continually varying.

The dynamics of the slaker temperature response included a dead time of 90 seconds and a long time constant of 1,000 seconds. This short dead time is due to the design of the process with the green liquor temperature control being located close to the slaker. The long time constant is due primarily to the size of the slaker vessel. Even with dynamics such as these, open loop control is poor since the operator would need to continually monitor the slaker temperature and make changes allowing for the long response time of the system. Figure 6 shows that the operator only made 3 adjustments to the green liquor temperature set point over a 16-hour period, even though the slaker temperature is continually below set point.

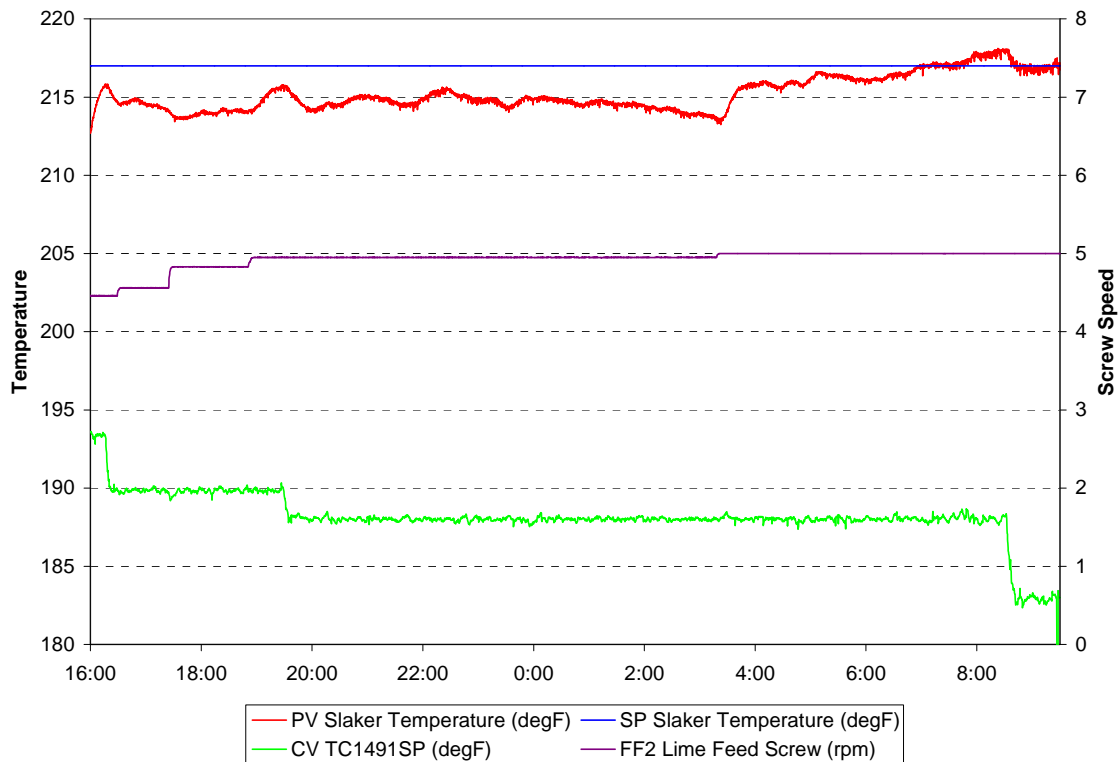

Figure 6: Slaker Temperature in Manual Control

The MPC control performance of the slaker temperature is shown in Figure 7. A summary of the performance improvements obtained is shown in Table III where "error" is defined as the absolute difference in temperature between the set point and the process variable. By using an automatic control strategy with a continual adjustment of the green liquor temperature, slaker temperature control has been improved dramatically with an associated reduction in operator workload. Automatic control of the Causticizer conductivity was also realized using the MPC controller. In this application, a 1% increase in causticizing efficiency was achieved.

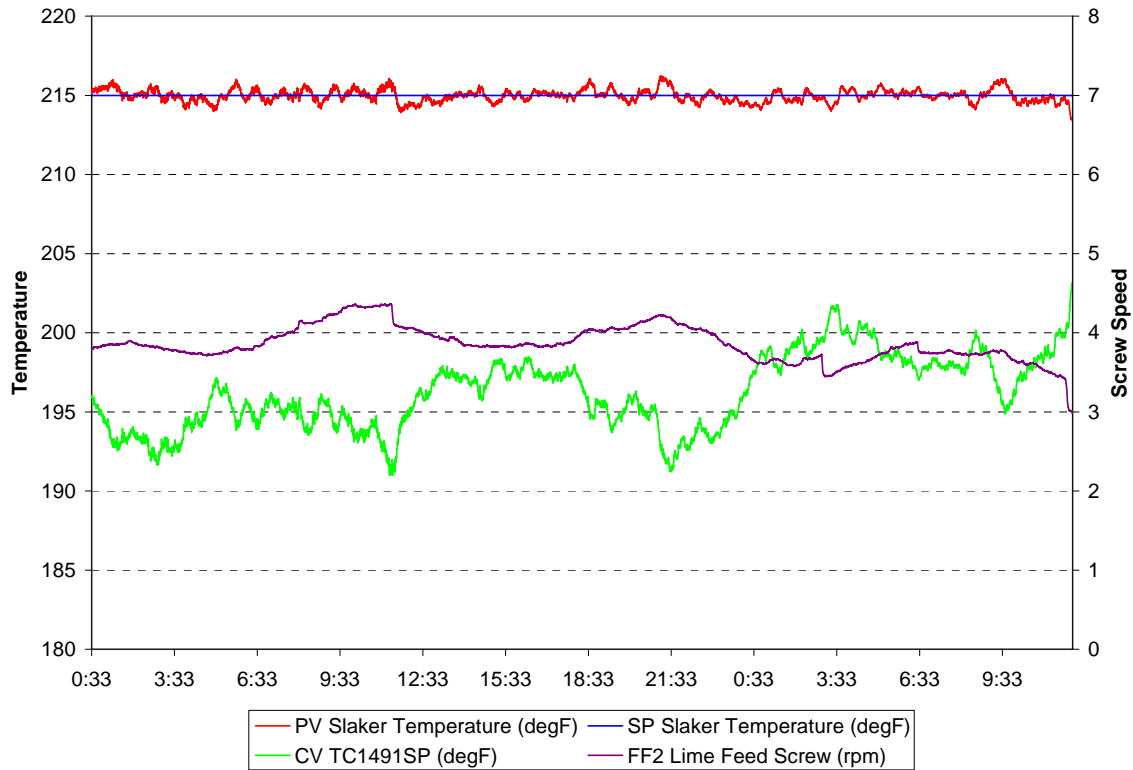

Figure 7: Slaker Temperature MPC Control

Table III: Slaker Temperature Performance Comparison

PERFORMANCE INDEX	MANUAL CONTROL	MPC CONTROL	IMPROVEMENT
Mean error	1.75	0.02	98%
Peak error	4.28	1.65	61%
Standard deviation	1.1	0.39	65%

6 Extraction Stage After-Tower pH Control

Control of extraction stage after tower pH is challenging due to the long and varying dead time, and that fact that the dead time and the process gain change by a factor of with a 2.5:1 with production rate. The process dead time is five times longer than the process time constant, making this control application particularly difficult.

Initial process response estimates were configured in the MPC controller according to information from operators and engineers working at the plant. They estimated that the process had about two hours of dead time and a time constant of about 17 minutes. A change in the control variable (CV) of 0.5% chlorine dioxide (% applied ratio) was estimated to change pH by 2.0 units.

Since production rate change could affect the process dynamics by a factor of 2.5, the MPC controller was configured with a set of process models to cover the entire production range. Four different models were configured (see Figure 8). The main differences between the models were the process gain and dead time. Process gain was ranging from 0.6 to 2.0 and dead time from 2,000 to 6,000 seconds. Lower production rates will require models with higher gain and longer dead time. As production rate increases, model gain and dead time will decrease. The MPC controller will dynamically load the appropriate model according to the production rate as this provides a faster solution in this case than relying on adaptation alone to correct for the changes in the process.

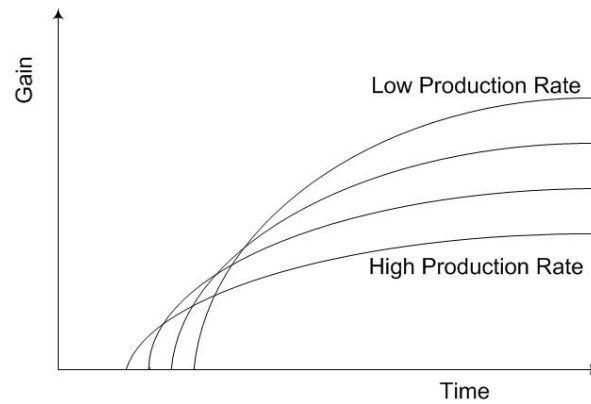

Figure 8: Open Loop Process Response Models used for MPC

Figure 9 shows the control performance achieved by the operator and the MPC control. The MPC controller was successful at controlling the pH in spite of significant production rate changes. The mill had attempted to implement a Dahlin type controller but they had difficulties keeping the process stable due to the long process dead time so the process was controlled manually. Table IV shows the comparison between the MPC control and manual control. The automatic control allowed operation at an average set point of 10.2 instead of 10.5, resulting in a reduction of caustic addition with corresponding savings of about \$100,000 per year.

Table IV: E Stage pH Control Improvement Summary

PERFORMANCE INDEX	MANUAL CONTROL	MPC CONTROL	IMPROVEMENT
Standard Deviation	0.089	0.032	64%

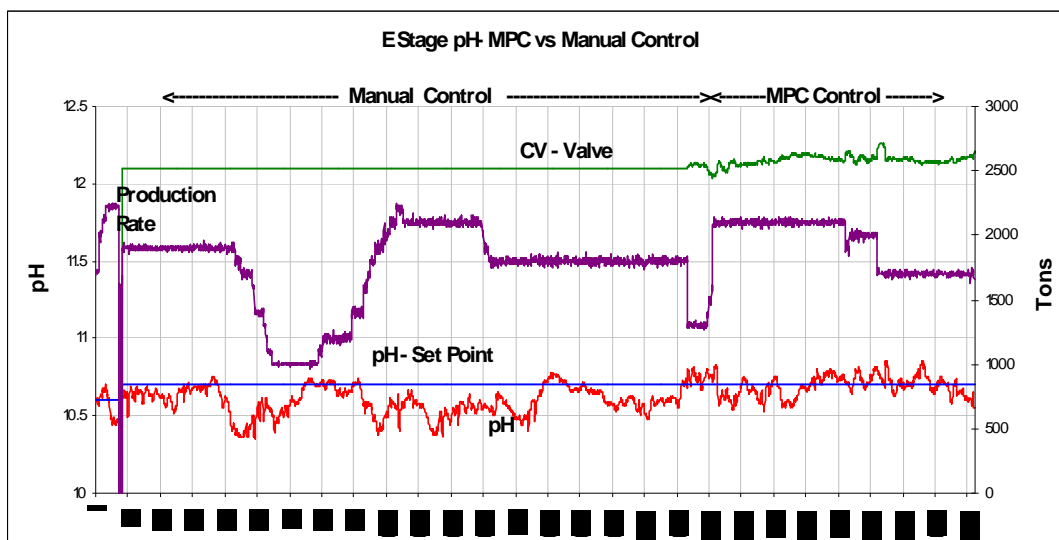

Figure 9: pH Control Comparison

7 Conclusions

The application of model predictive control techniques to these four typical processes demonstrates the ability for paper makers to significantly improve their process control with this innovative control tool. The economics of all the applications shown was very attractive with payback times of less than six months. It is estimated that benefits of between \$1 million to \$2 million in terms of reduced chemical and energy costs are potentially available in a typical kraft mill, with project payback times of less than 6 months. Examples of other industrial applications are given in [9-12].

8 References

- [1] Zervos C.C., G.A. Dumont, "Deterministic Adaptive Control Based on Laguerre Series Representation", *Int. J. Control*, Vol. 48, 1988, pp. 2333-2359.
- [2] Dumont G.A., C.C. Zervos, "Adaptive Control Based on Orthonormal Series Representation", 2nd IFAC Workshop on Adaptive Systems in Signal Processing and Control, Lund, Sweden, 1986, pp. 371-376.
- [3] Zervos C.C., P.R. Bélanger, G.A. Dumont, "Controller Tuning Using Orthonormal Series Identification", *Automatica*, 24, 1988, 165-175.
- [4] Elshafei A.L., G.A. Dumont, A. Elnaggar, "Adaptive GPC Based on Laguerre Filters Modeling", *Automatica*, Vol. 30, No. 12, 1994, pp. 1913-1920.
- [5] Dumont G.A., Y. Fu, "Nonlinear Adaptive Control via Laguerre Expansion of Volterra Kernels", *Int. J. Adaptive Control and Signal Processing*, Vol. 7, No. 5, 1993, pp. 367-382.
- [6] Fu Y., G.A. Dumont, "Optimum Laguerre Time Scale and its On-line Estimation", *IEEE Transactions on Automation Control*, Vol. 38, No. 6, 1993, pp. 934-938.
- [7] Huzmezan M., T. Janiewicz, D. Meade, "Industrial Automation with BrainWave MultiMax - An Adaptive Model Based Predictive Controller", 4th Intl Conference on Industrial Automation, Montreal, QC, Jun 9-11, 2003.
- [8] Huzmezan M., B. Gough, G. Dumont, S. Kovac, "Time Delay Integrating Systems - A Challenge for Process Control Industries - A Practical Solution", *Control Engineering Practice* – Feb 2002.
- [9] Gough B., S. Kovac, L. DeVito, D. Quick, "Model Predictive Control of Batch Temperature" WBF 2004, Chicago, IL, May 16-19, 2004.
- [10] Bassett C., R. Akkerman, S. Kovac, D. Lillfors, "Reducing Variability in Pulp Brightness at the Blandin Paper Company" *Pulp and Paper Magazine*, Jan 2003, pp. 48-50.
- [11] Bittante G., "Application of Advanced Control Systems in the North American Lime Industry", 10th Intl Lime Congress, Washington, DC, May 7-10, 2002.
- [12] Gough B., J. Kay, M. Weaver, S. Kovac, "Advanced Predictive Adaptive Control of Steam Header Pressure, Saveall Consistency and Reel Brightness in a TMP Newsprint Mill" *Control Systems 2002*, Stockholm, Sweden, Jun 3-5, 2002.